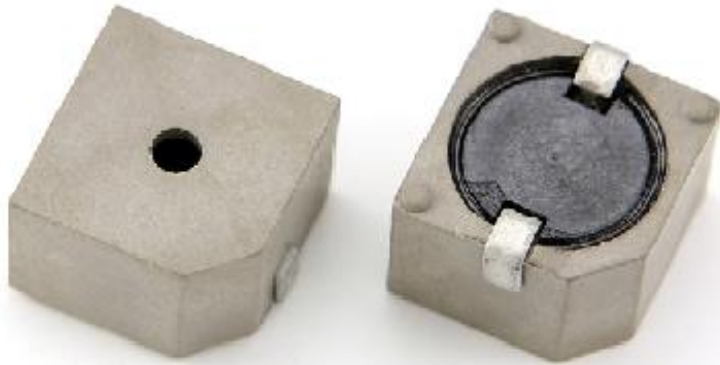

	DATE	29-04-2020	SPECIFICATION	Changzhou Cre-sound Electronics Co., Ltd
	PAGE	1/8		www.cre-soundbuzzer.com
	Version	A/0		www.wj-lianhua.com
	<i>MODEL NAME: LEB1310BS-05S-2.4-R</i>			

SPECIFICATION FOR APPROVAL ELECTRO-MAGNETIC BUZZER

Model Name	LEB1310BS-05S-2.4-R
Note	

Product Photo	Cre-sound
	DRAWN: 周文占
	CHECKED: 许海
	APPROVED: 宋雪琪
Customer Confirmation:	

	DATE	29-04-2020	SPECIFICATION	Changzhou Cre-sound Electronics Co., Ltd
	PAGE	3/8		www.cre-soundbuzzer.com
	Version	A/0		www.wj-lianhua.com
	<i>MODEL NAME: LEB1310BS-05S-2.4-R</i>			

LEB1310BS-05S-2.4-R ELECTRO-MAGNETIC BUZZER

No.	Technical terms	Value
1	Rated Voltage (VDC)	5
2	Operating Voltage (VDC)	3~6.5
3	☆0*Current Consumption (mA)	≤30
4	☆*Sound Output at 10cm (dB)	≥85
5	☆*Resonant Frequency (Hz)	2400±300
6	Operating Temperature (°C)	-40~+85
7	Storage Temperature (°C)	-40~+90
8	Weight (g)	3.0
9	Housing Material	PPS
10	RoHS	Yes

*Value applying at rated voltage

☆Test Basic State: Temp(20±2°C), Humidity(40~70%RH), Air pressure(860~1060hPa).

DIMENSIONS (UNIT: mm)

Tolerance: ±0.5mm Except Specified

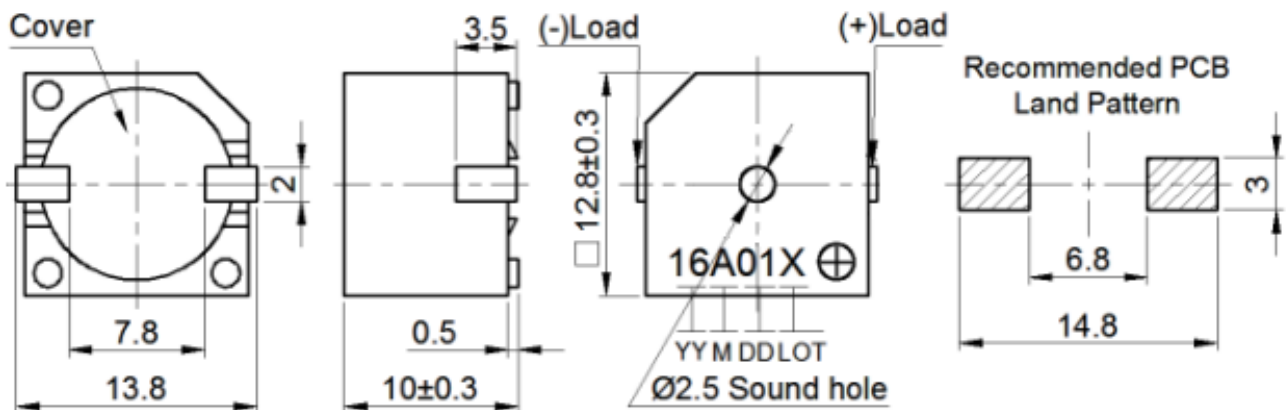

Changzhou Cre-sound Electronics Co., Ltd

Tel: +86-519-86322167; Fax: +86-519-86702455

E-mail: sales3@wj-lianhua.com

	DATE	29-04-2020	SPECIFICATION	Changzhou Cre-sound Electronics Co., Ltd
	PAGE	4/8		www.cre-soundbuzzer.com
	Version	A/0		www.wj-lianhua.com
<i>MODEL NAME: LEB1310BS-05S-2.4-R</i>				

TEST METHOD:

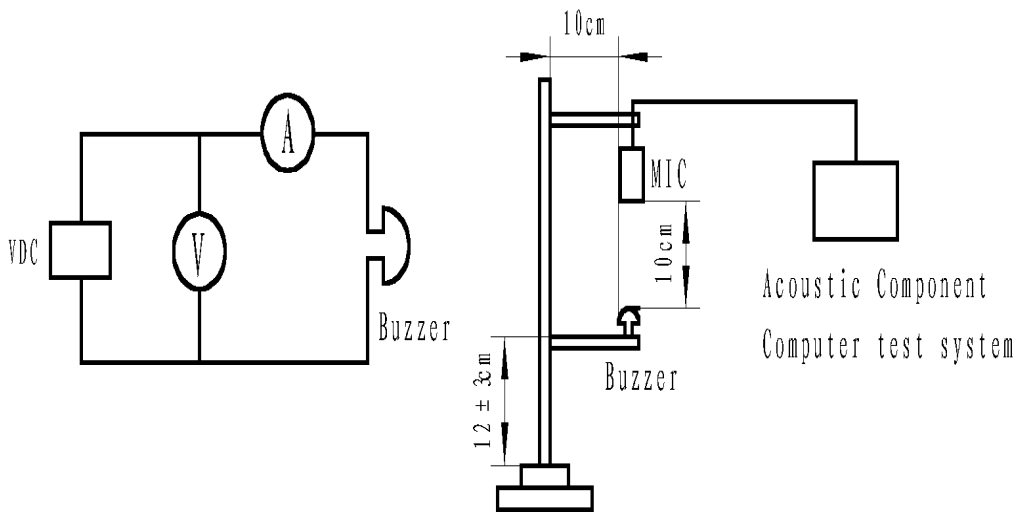

TYPICAL CHARACTERISTIC CURVES OF LEB1310BS-05S-2.4-R

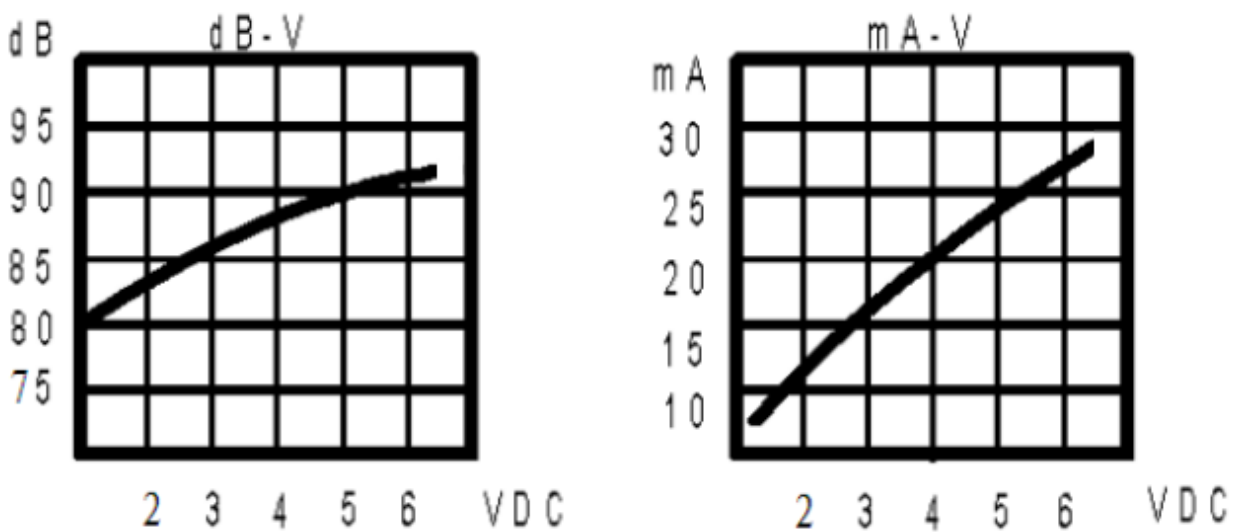

	DATE	29-04-2020	SPECIFICATION	Changzhou Cre-sound Electronics Co., Ltd
	PAGE	5/8		www.cre-soundbuzzer.com
	Version	A/0		www.wj-lianhua.com
	MODEL NAME: LEB1310BS-05S-2.4-R			

RELIABILITY TEST:

NO.	ITEM	TESTING CONDITION	VARIANCE AFTER TEST
1	High temp. storage	The part shall be capable of withstanding a storage temperature is $+90^{\circ}\text{C}$ for 120 hours	After being placed for 2 to 4hrs at room temp, the product shall meet specifications, except the SPL should be in $\pm 10\text{dB}$ compared with initial one.
2	Low temp. storage	The part shall be capable of withstanding a storage temperature is -40°C for 120 hours	
3	Temp. Cycle	Total 5 cycles, 1 cycle consisting of $-40 \pm 2^{\circ}\text{C}$, 30 minutes $20 \pm 5^{\circ}\text{C}$ 15 minutes $120 \pm 2^{\circ}\text{C}$, 30 minutes $20 \pm 5^{\circ}\text{C}$ 15 minutes	
4	Humidity Test	$40 \pm 2^{\circ}\text{C}$, 90~95% RH, 120 hours	
5	Vibration Test	To-and-fro. sweep time (from 10 to 55 Hz and then 55 to 10Hz) under single amplitude of 1.52mm is 1 minute. The vibration test shall consist of 2 hours per plane in each three mutually perpendicular planes for a total time of 6 hours.	The SPL shall meet specification.
6	Shock	Sounder shall be measured after being applied shock (980m/s^2) for each three mutually perpendicular directions to each of 3 times by half sine wave.	After the test, the product shall meet specifications, except the SPL should be in $\pm 10\text{dB}$ compared with initial one.
7	Drop Test	The part only shall be dropped from the height of 70cm onto 10mm thick wooden board each 3 times in 3 axial directions(x,y&z) (a total of 9 times).	After the test part shall meet specifications without any degradation in appearance and performance.
8	Lead pull	The part shall be pushed with a force of 9.8N for 10 ± 1 seconds behind the part. 	The SPL shall meet specification.
9	Recommended temp. Profile for Reflow Oven	Shown in Fig.1	The SPL shall meet specification.

Warranty: For a period of one year from date of manufacture under normal operations.

	DATE	29-04-2020	SPECIFICATION	Changzhou Cre-sound Electronics Co., Ltd
	PAGE	6/8		www.cre-soundbuzzer.com
	Version	A/0		www.wj-lianhua.com
<i>MODEL NAME: LEB1310BS-05S-2.4-R</i>				

Recommended Temp. Profile for Reflow Oven (Fig.1)

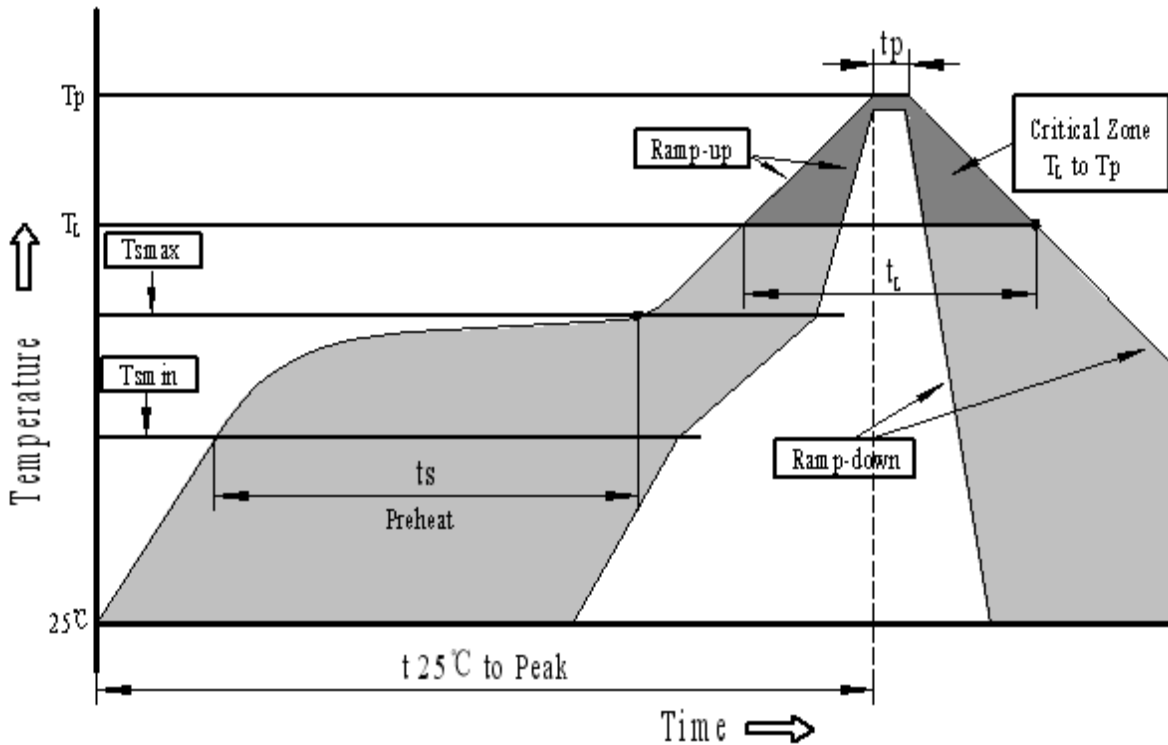

Profile Feature	Pb-Free Assembly
Average ramp-up rate(T_L to T_p)	3°C/second max.
Preheat	
-Temperature Min.(T_{Smin})	150°C
-Temperature Min.(T_{Smax})	200°C
-Temperature Min.(t_s)	60~180 seconds
T_{Smax} to T_L	
-Ramp-up Rate	3°C/second max.
Time maintained above:	
- Temperature(T_L)	217°C
-Time(t_L)	60~150 seconds
Peak temperature(T_p)	245°C+0/-5°C
Time within 5°C of actual Peak temperature (t_p)	6 seconds max.
Ramp-down Rate	6°C/second max.
Time 25°C to Peak Temperature	8 minutes max.

Changzhou Cre-sound Electronics Co., Ltd

Tel: +86-519-86322167; Fax: +86-519-86702455

E-mail:sales3@wj-lianhua.com

	DATE	29-04-2020	SPECIFICATION	Changzhou Cre-sound Electronics Co., Ltd
	PAGE	7/8		www.cre-soundbuzzer.com
	Version	A/0		www.wj-lianhua.com
	<i>MODEL NAME: LEB1310BS-05S-2.4-R</i>			

PACKING:

Changzhou Cre-sound Electronics Co., Ltd
 Tel: +86-519-86322167; Fax: +86-519-86702455
 E-mail: sales2@wj-lianhua.com

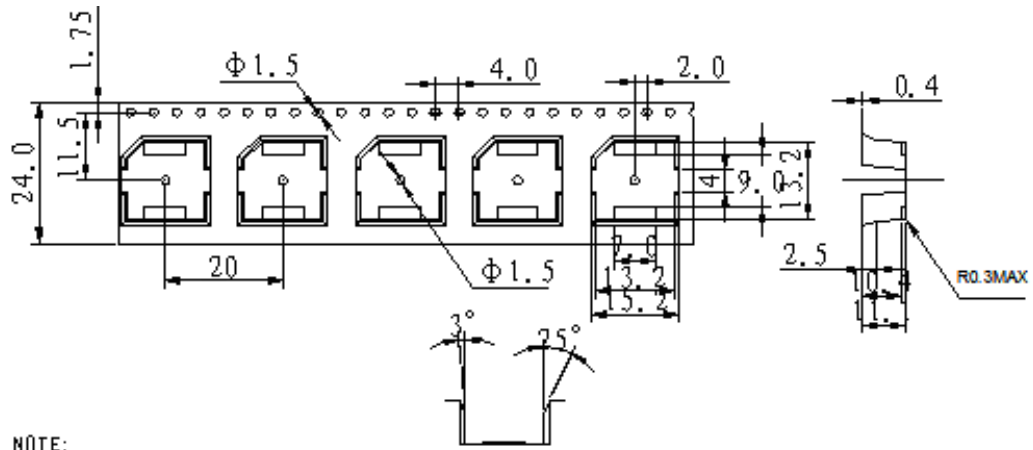

NOTE:

1. 10 sprocket hole pitch cumulative tolerance $\pm 0.2\text{mm}$.
2. All dimensions meet EIA-481-D requirements.
3. Thickness: $0.4 \pm 0.05\text{mm}$.
4. Component loaded per 13" reel: 300 pcs.

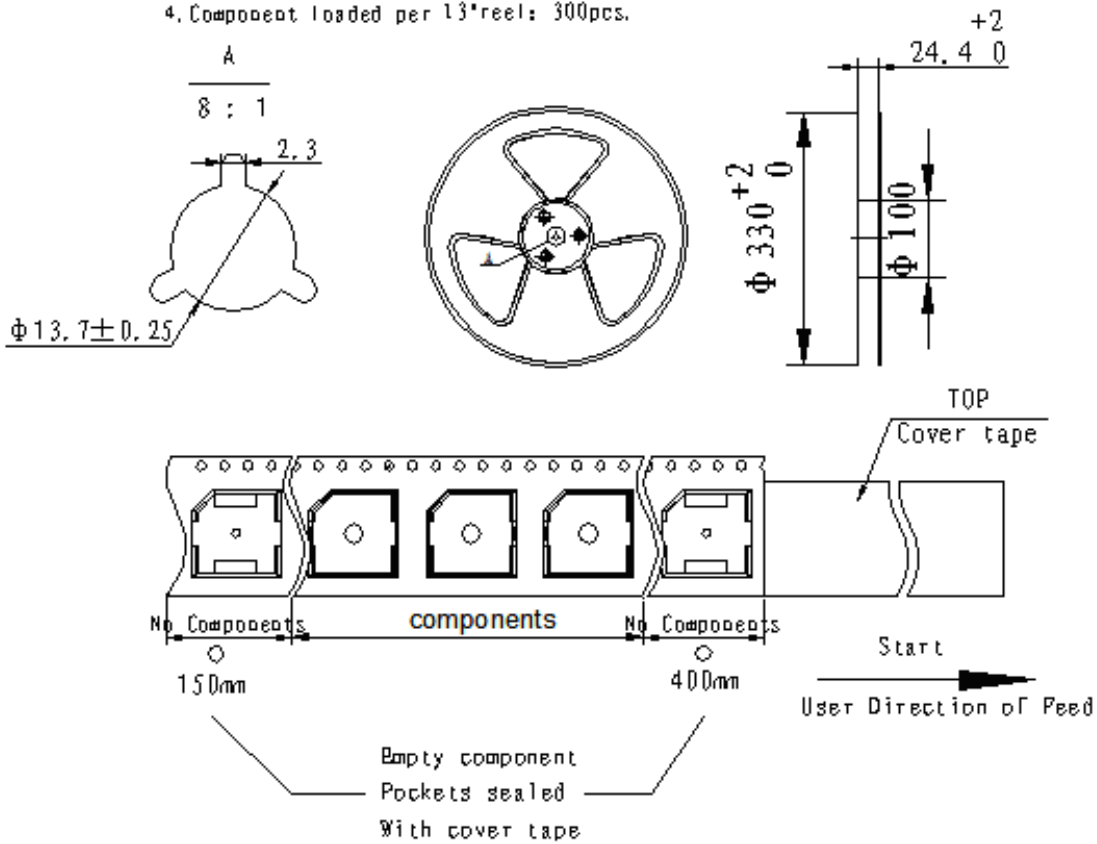

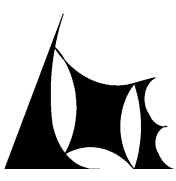
	DATE	29-04-2020	SPECIFICATION	Changzhou Cre-sound Electronics Co., Ltd
	PAGE	8/8		www.cre-soundbuzzer.com
	Version	A/0		www.wj-lianhua.com
MODEL NAME: LEB1310BS-05S-2.4-R				

PACKING:

Changzhou Cre-sound Electronics Co., Ltd
 Tel: +86-519-86322167; Fax: +86-519-86702455
 E-mail: sales2@wj-lianhua.com

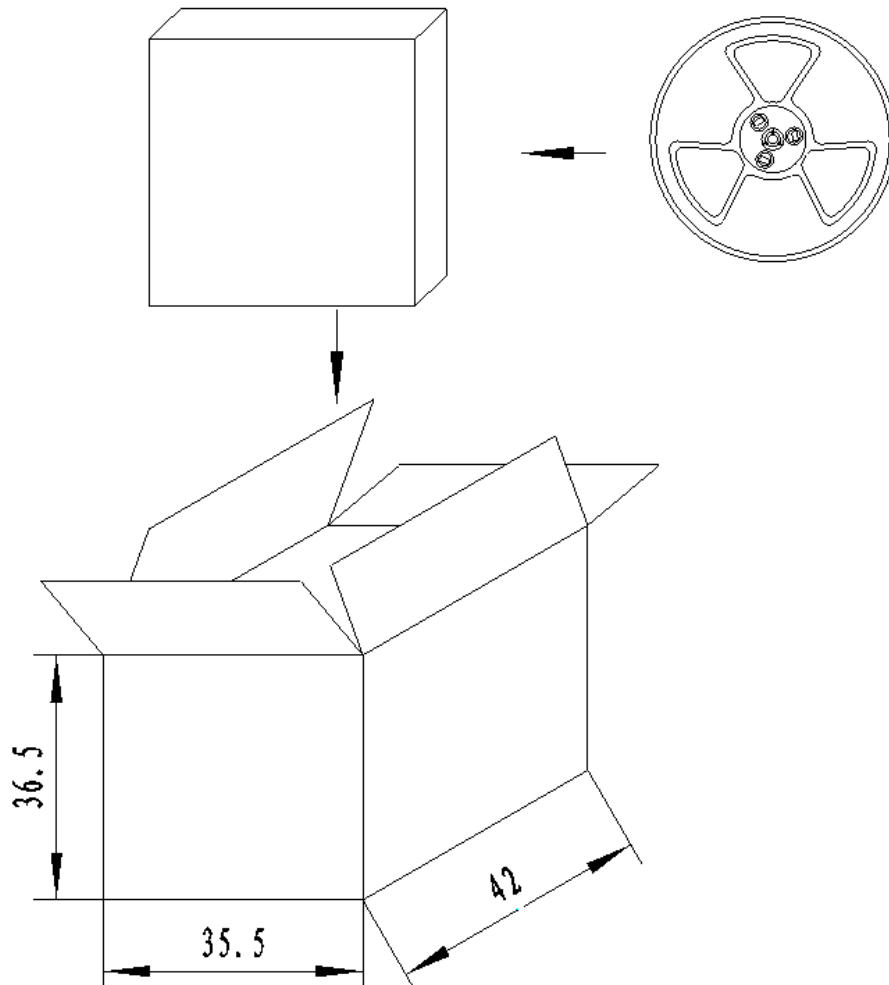

NOTES:

- 1.300 PCS per box
- 2.Total 10 boxes per carton
- 3.Total 3000 PCS carton

Changzhou Cre-sound Electronics Co., Ltd
Tel: +86-519-86322167; Fax: +86-519-86702455
E-mail:sales2@wj-lianhua.com