

Radio-frequency probe

HFS-840 303 090 A 8043 Y6 M

Item HFS-840-0564



GO TO PRODUCT

ingun[®]

Partner for Future Technology

- Long standard series
- Up to 4 GHz
- Cable interface MCX
- Screw-in version
- Receptacles: KS-810 M5-R, KS-810 M5-F

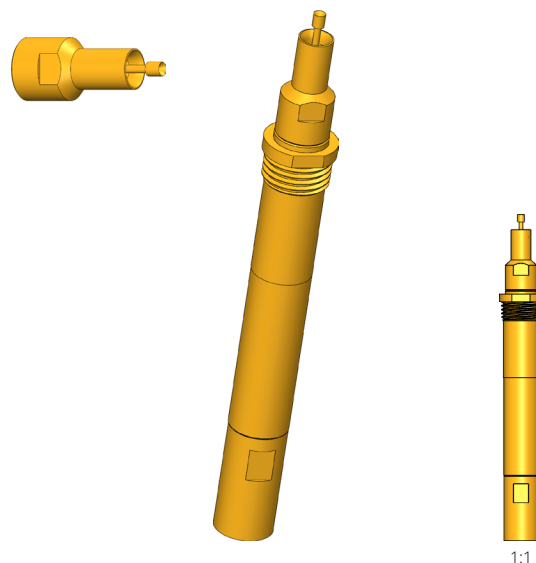

1:1

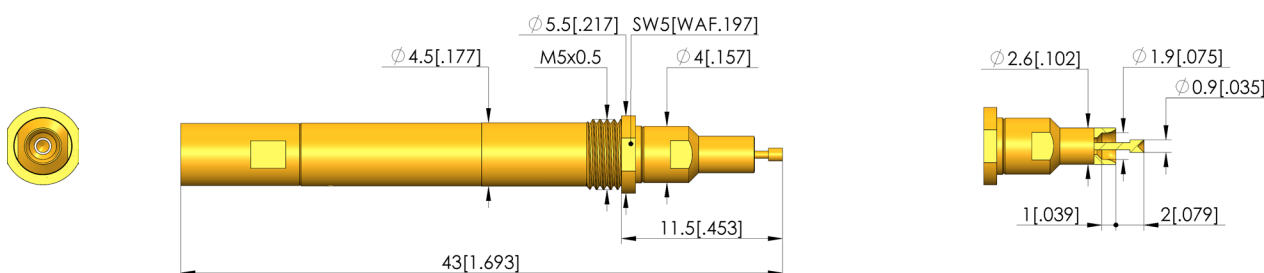

General data

Product group:	HFS radio-frequency test probes
Series:	HFS-840
Sub-series:	HFS-840 M screw-in
Grid:	6.5 mm [255 mil]
DUT / contact:	U.FL, AMC, Sunridge MCB
Installation type:	Screw-in
DUT interface gender :	M signal conductor male / pin
Floating mount:	No
Non-rotating:	Yes
Continuous plunger:	Yes
Interface of compatible assembly:	MCX 50 Ohm
Compatible assembly interface gender :	M signal conductor male / pin
KS sub-series:	KS-810 M, screw-in version
Min. temperature:	- 40 °C [- 104 °F]
Max. temperature:	+ 80 °C [+ 176 °F]
RoHS-compliant:	RoHS-3;6c

Outer conductor data

Outer conductor tip style:	43 centring for outer side of connector
Outer conductor tip style diameter:	2.6 mm [.102 in]
Spring force of entire outer conductor at working stroke:	6 N [21.5 ozf]
Outer conductor working stroke:	4 mm [.157 in]
Outer conductor maximum stroke:	5 mm [.196 in]
Exchangeable outer conductor:	KO-810343260A-Y6
Outer conductor max. current load capacity:	10 A

Inner conductor data

Inner conductor tip style:	03 inverse cone
Inner conductor tip style diameter:	0.9 mm [.035 in]
Inner conductor tip style material:	3 CuBe
Inner conductor tip style surface:	A gold
Number of inner conductors:	1
Exchangeable inner conductor:	GKS-051-0065
Inner conductor working stroke:	2 mm [.078 in]
Spring force of each inner conductor at working stroke:	2 N [7.19 ozf]
Inner conductor maximum stroke:	3.7 mm [.145 in]
Inner conductor max. current load capacity:	3 A

RADIO-FREQUENCY TEST PROBES

Radio-frequency probe

HFS-840 303 090 A 8043 Y6 M

Item HFS-840-0564



GO TO PRODUCT

ingun[®]

Partner for Future Technology

Electrical data

Frequency range up to:

Impedance:

4 GHz

50 Ohm

Mechanical data

Total spring force at working stroke:

Total length:

Barrel diameter:

Installation height without receptacle:

Torque in receptacle:

8 N [28.7 ozf]

43 mm [1.69 in]

4.5 mm [.177 in]

11.5 mm [.452 in]

10 - 20 cNm [.885 - 1.77 lbf·in]

INGUN Prüfmittelbau GmbH

Max-Stromeyer-Straße 162
78467, Constance, Germany
Phone +49 7531 8105-0
Customer hotline +49 7531 8105-888
Fax +49 7531 8105-65
info@ingun.com



Prices and delivery times on request.
Technical changes reserved. 04/24_GB

Learn more about
Radio-frequency test probes



ingun.com