

Radio-frequency probe

HFS-810 303 150 A 5342 F M

Item HFS-810-0455



GO TO PRODUCT

ingun[®]

Partner for Future Technology

- Long standard series
- Up to 2 GHz
- Cable interface MCX
- Screw-in version
- Receptacles: KS-810 M5-R, KS-810 M5-F

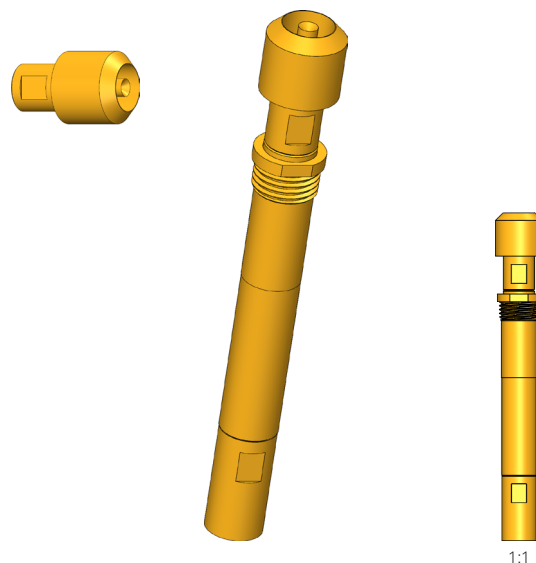

1:1

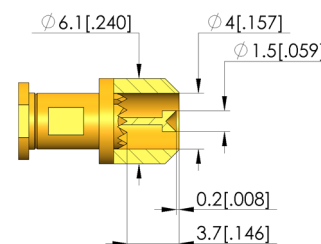
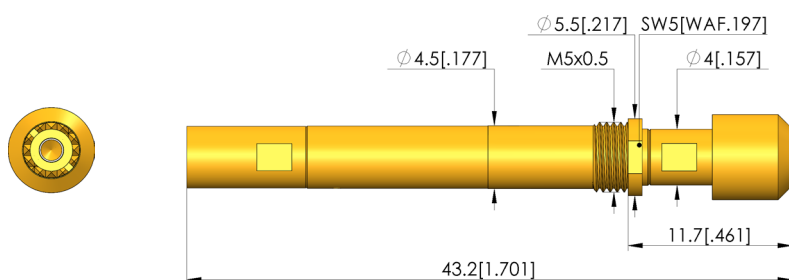

General data

Product group:	HFS radio-frequency test probes
Series:	HFS-810
Sub-series:	HFS-810 M screw-in
Grid:	6.6 mm [259 mil]
DUT / contact:	FAKRA
Installation type:	Screw-in
DUT interface gender :	M signal conductor male / pin
Floating mount:	No
Non-rotating:	Yes
Continuous plunger:	Yes
Interface of compatible assembly:	MCX 50 Ohm
Compatible assembly interface gender :	M signal conductor male / pin
KS sub-series:	KS-810 M, screw-in version
Min. temperature:	- 40 °C [- 104 °F]
Max. temperature:	+ 80 °C [+ 176 °F]
RoHS-compliant:	RoHS-3;6c

Outer conductor data

Outer conductor tip style:	42 centring for inner side of plug connector
Outer conductor tip style diameter:	6.1 mm [.240 in]
Spring force of entire outer conductor at working stroke:	4 N [14.3 ozf]
Outer conductor working stroke:	4 mm [.157 in]
Outer conductor maximum stroke:	5 mm [.196 in]
Exchangeable outer conductor:	KO-810342610A-F
Outer conductor max. current load capacity:	10 A

Inner conductor data

Inner conductor tip style:	03 inverse cone
Inner conductor tip style diameter:	1.5 mm [.059 in]
Inner conductor tip style material:	3 CuBe
Inner conductor tip style surface:	A gold
Number of inner conductors:	1
Exchangeable inner conductor:	GKS-051-0011
Inner conductor working stroke:	2 mm [.078 in]
Spring force of each inner conductor at working stroke:	1.3 N [4.67 ozf]
Inner conductor maximum stroke:	3.7 mm [.145 in]
Inner conductor max. current load capacity:	3 A

RADIO-FREQUENCY TEST PROBES

Radio-frequency probe

HFS-810 303 150 A 5342 F M

Item HFS-810-0455



GO TO PRODUCT

ingun[®]

Partner for Future Technology

Electrical data

Frequency range up to:
Impedance:

2 GHz
50 Ohm

Mechanical data

Total spring force at working stroke: 5.3 N [19.0 ozf]
Total length: 43.2 mm [1.70 in]
Barrel diameter: 4.5 mm [.177 in]
Installation height without receptacle: 11.7 mm [.460 in]
Torque in receptacle: 10 - 20 cNm [.885 - 1.77 lbf·in]

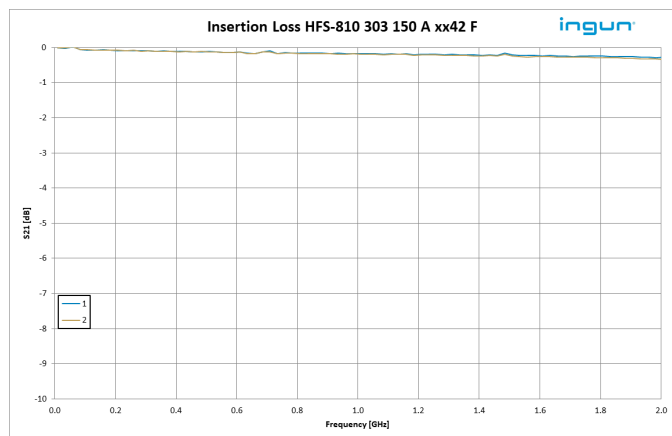
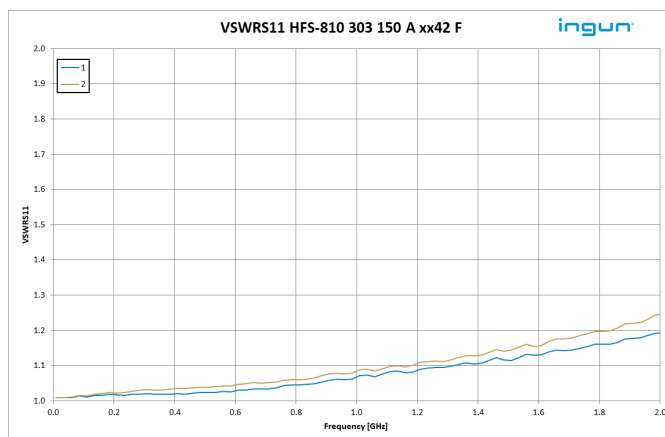
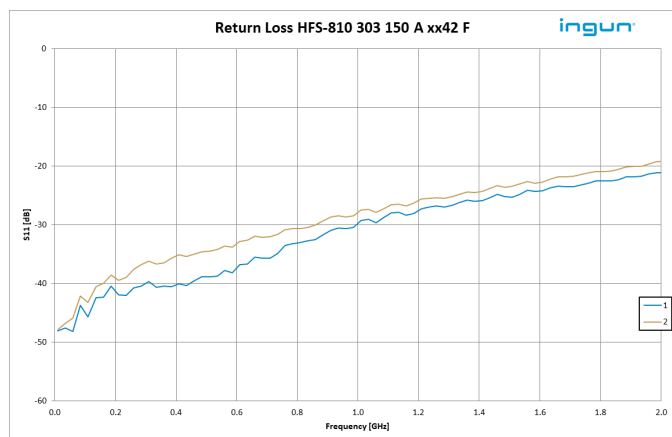

HFS-810 303 150 A 5342 F, RF measurement setup

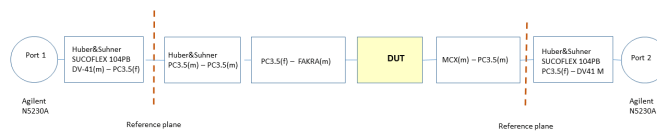

INGUN Prüfmittelbau GmbH

Max-Stromeyer-Straße 162
78467, Constance, Germany
Phone +49 7531 8105-0
Customer hotline +49 7531 8105-888
Fax +49 7531 8105-65
info@ingun.com



Prices and delivery times on request.
Technical changes reserved. 04/24_GB

Learn more about
Radio-frequency test probes



ingun.com