

# Technical data sheet

## Cable gland, metric thread, set with locknut, light grey

Art.-Nr. 2022762



The quickest and most convenient way of providing strain relief and tightness with cable glands on junction boxes and housings is with the tried-and-trusted V-TEC VM cable glands from OBO. With the integrated sealing lip and the special OBO slat technology, protection class IP68 is achieved. Strain relief and tightness have been tested to DIN EN 62444.

The connecting threads of the cable glands are metric or PG and are therefore suitable for universal use. Once screwed in place, the installation is there forever, as the optimum thread adjustment with the right pitch ensures permanent resistance to shaking.

Applications: From private housing with junction boxes up to industrial applications in the distributor cabinet.

Temperature range: -20 °C to +65 °C.



**PA** Polyamide

### Master data

Item No.	2022762
Type	V-TEC VM12+ LGR
Description 1	Cable gland
Description 2	with locknut
Dimension	M12
Colour	Light grey
RAL number	7.035,00
Material	Polyamide
Material symbol	PA
Smallest sales unit	50,00 pcs
Weight	0,34 kg/100 pcs.

### Technical specifications

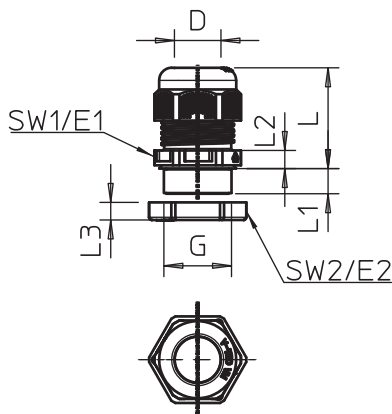

Dimension E1	16,50 mm
Dimension E2	19,00 mm
Dimension L min.	18,50 mm
Dimension L max.	23,50 mm
Dimension L1	8,00 mm
Dimension L2	5,00 mm
Dimension L3	5,00 mm
SW 1	15,00 mm
SW 2	17,00 mm
Version	Straight
Type of seal	Sealing ring
Bend protection	<input checked="" type="checkbox"/>
Sealing range D	3,50 - 7,00 mm
explosion-proof	<input checked="" type="checkbox"/>
Flat cable threaded connection	<input checked="" type="checkbox"/>
For Ex zone	Without
For Ex zone gas	Without
For Ex zone dust	Without
Flame resistant	flame resistant to VDE 0471/DIN 695 Part 2-1, test temperature 650° C
Thread	M12 x 1,5
Thread type	Metric
Thread length	8,00 mm

# Technical data sheet

Cable gland, metric thread, set with locknut, light grey

Art.-Nr. 2022762



## Technical specifications

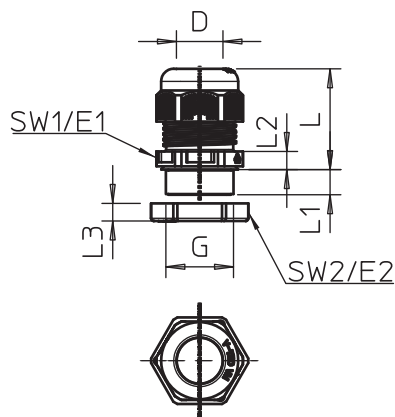

Thread increase	1,50 mm
Nominal thread size	12,00
Glass-fibre reinforced	<input checked="" type="checkbox"/>
Halogen-free	<input checked="" type="checkbox"/>
Installation torque	2,00 Nm
Multiple sealing insert	<input checked="" type="checkbox"/>
With locknut	<input checked="" type="checkbox"/>
Impact resistant	<input checked="" type="checkbox"/>
Protection rating	IP68
Splittable gland	<input checked="" type="checkbox"/>
Strain relief option	<input checked="" type="checkbox"/>